

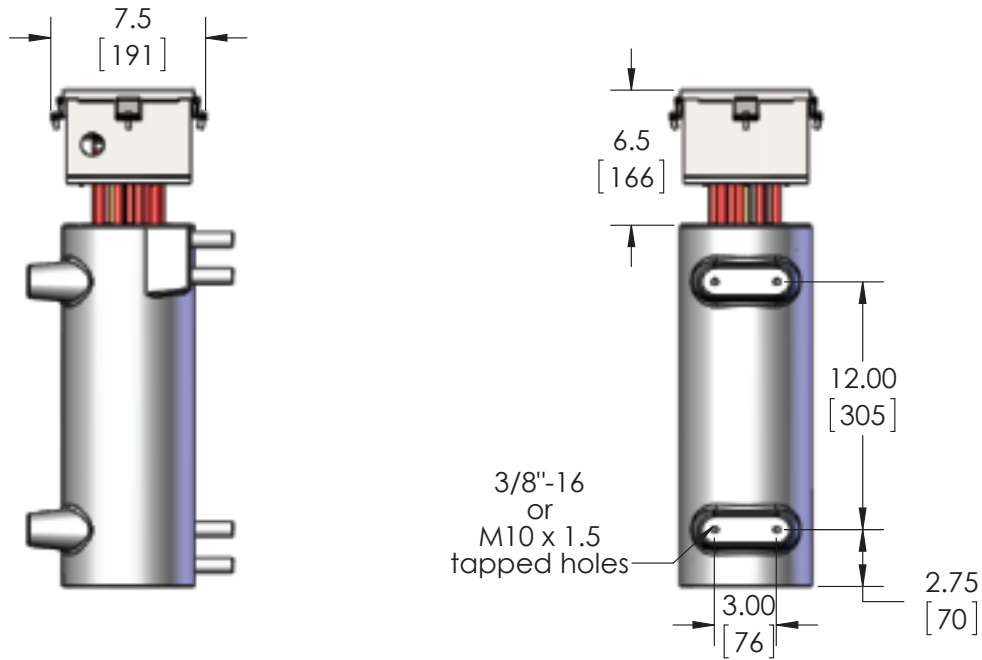

# CAST-X 3000 Circulation Heater

## MOISTURE-RESISTANT (NEMA 4) ENCLOSURE



### CAST-X 3000 Heating Profile: Delta-T Water

(Process Fluid = Water @ 42°F / 5.6°C Inlet Temp, Single Pass Using One Tube, 100% Power, Set Point 752°F / 400°C)

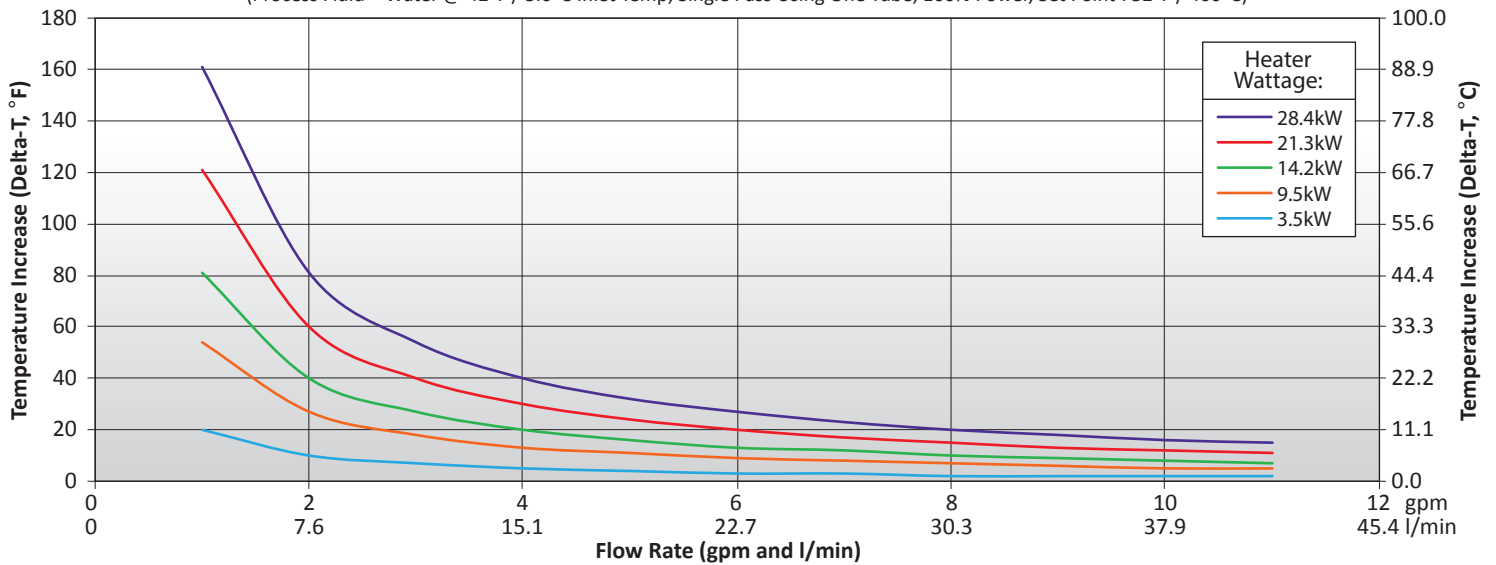

### CAST-X 3000 Pressure Drop Profile: Delta-P Water

(Process Fluid = Water. Change in Pressure from Inlet to Outlet, Single Pass Using One Tube)

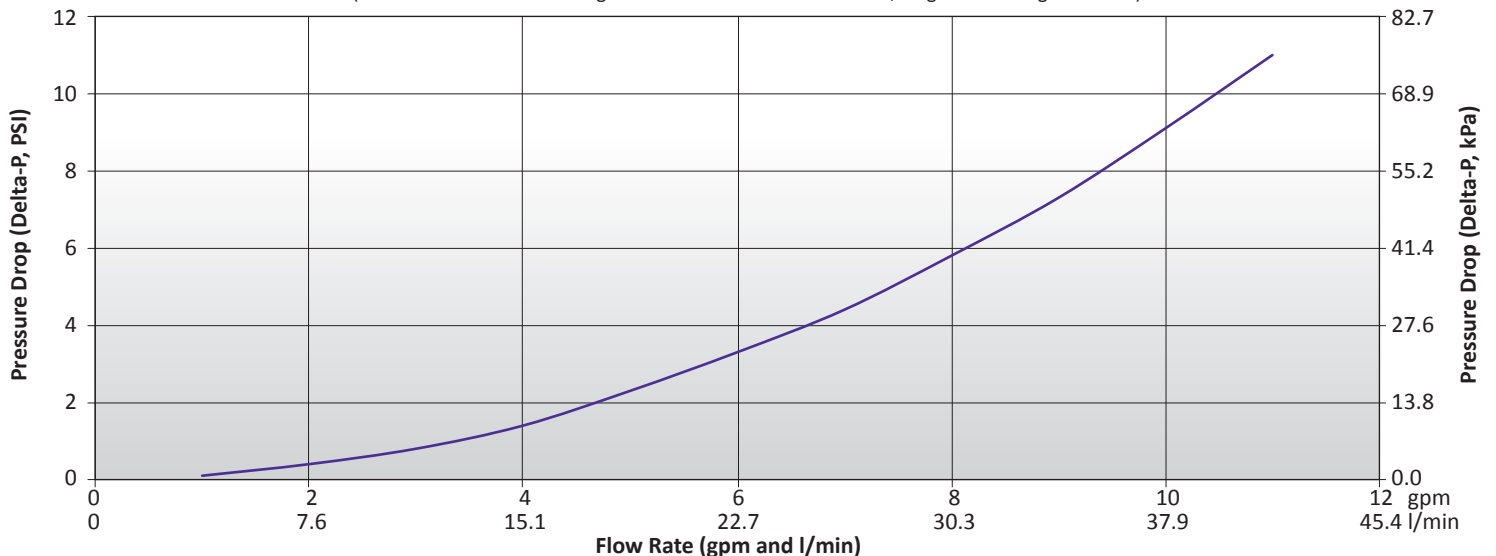

**EXPLOSION-PROOF (NEMA 7 / ATEX) ENCLOSURE**

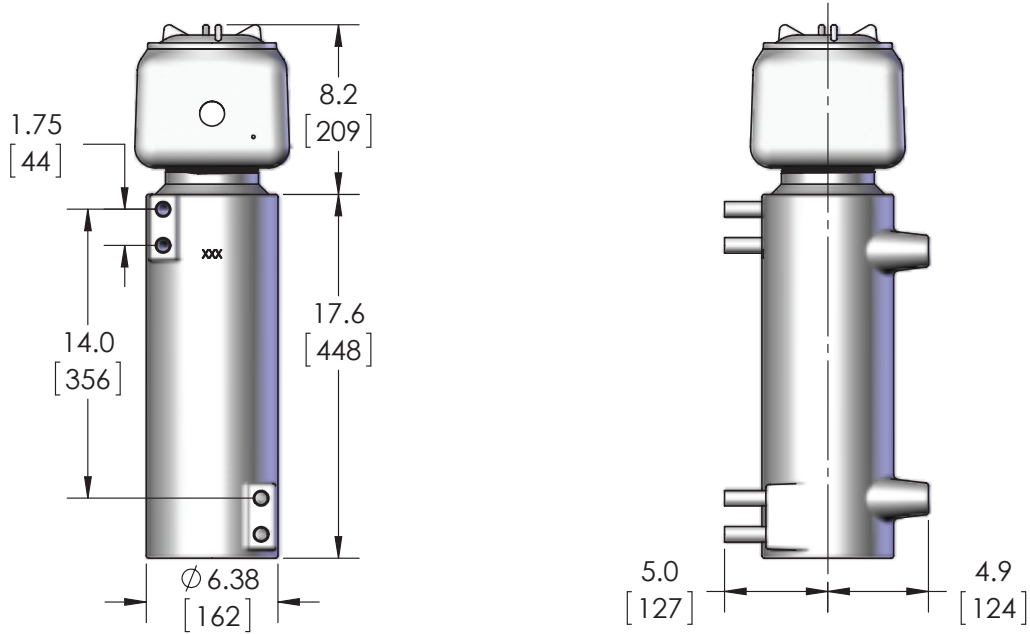

**CAST-X 3000 Heating Profile: Delta-T Air**

(Process Fluid = Air @ 100 psi (689 kPa), 70.7°F / 21.5°C, Single Pass Using One Tube, Set Point 752°F / 400°C)

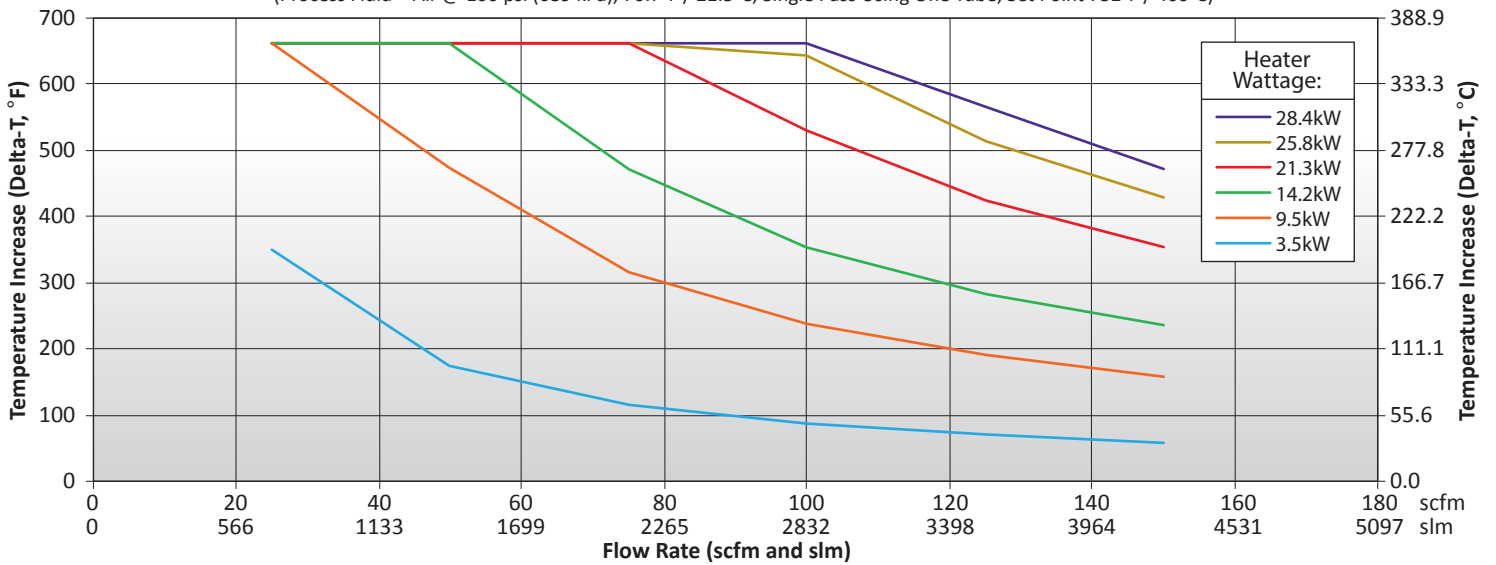

**CAST-X 3000 Heating Profile: Delta-P Air**

(Process Fluid = Air @ 100 psi (689 kPa), 70.7°F / 21.5°C, Single Pass Using One Tube, Set Point 752°F / 400°C)

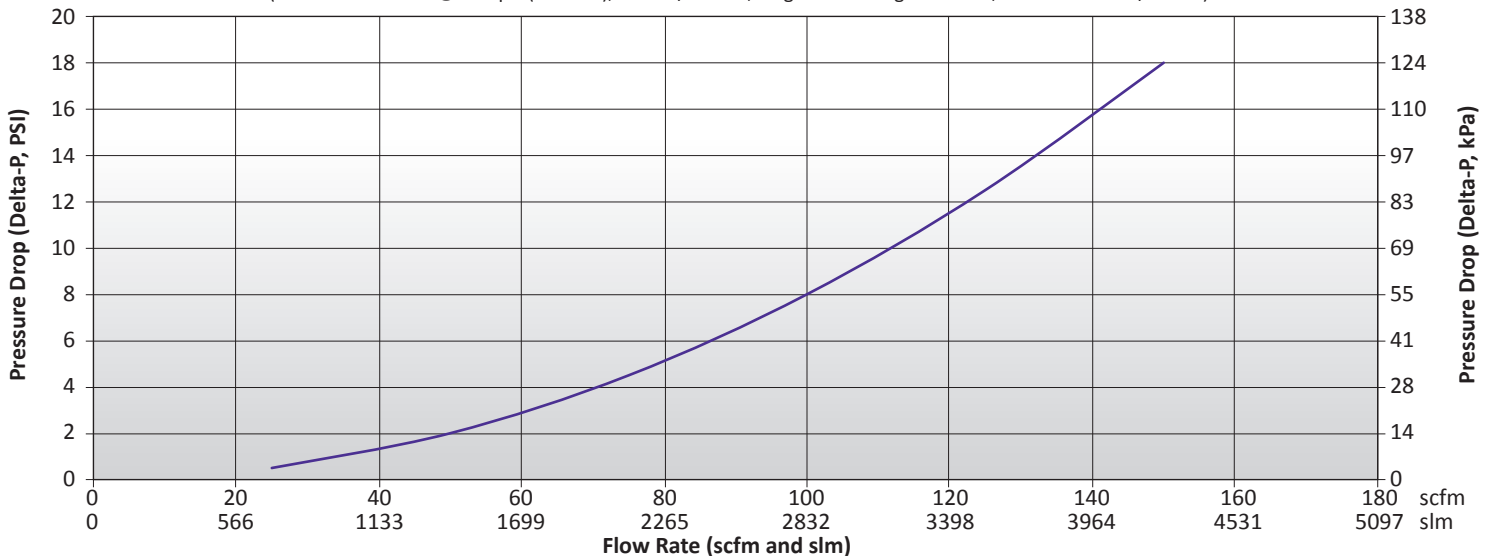

# CAST-X 3000 Circulation Heater

Engineering Expertise • Speed to Market • Operational Excellence

Cast Aluminum Solutions (CAS) manufactures the CAST-X line of circulation heaters, plus a broad range of heating, cooling, and non-thermal components. We are relied upon by OEMs and end-users alike throughout the semiconductor, medical device, aerospace, industrial gas, fluid-handling, food equipment, and energy markets.

Our multi-discipline team of engineers and technicians works closely with customers to develop practical solutions to complex process challenges. We utilize industry standard applications such as Finite Element Analysis (FEA), SolidWorks® 3-D CAD technology, and a range of structural analysis & thermal modeling tools.

CAS is an ISO 9001 Certified company with a fully-equipped R&D facility. Testing capabilities include X-Ray, ultrasound, helium leak, and infra-red technology, plus the latest coordinate measuring machines (CMM). Our in-house casting facility utilizes a permanent mold low-pressure casting process which reliably produces low-porosity, high-quality aluminum products. We offer an array of precision CNC machining options, finishing options such as electroless nickel plating, Teflon® coatings, clear-coat and hard-coat anodizing, plus high-value-added testing and inspection services.

Headquartered in Batavia, Illinois (just outside Chicago) we serve customers worldwide.

See the below map to locate a Sales Engineer, or contact CAS directly. We look forward to working with you.

With offices worldwide, the CAS Team of knowledgeable and experienced representatives is ready to assist with your project.

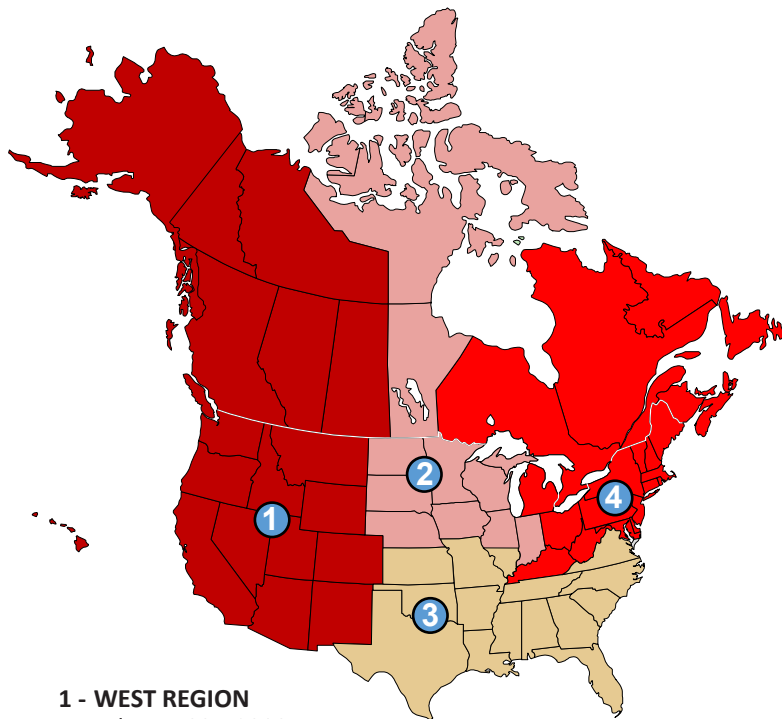

**1 - WEST REGION**  
Tel: 714-935-2999

**2 - MIDWEST REGION**  
Chicago Tel: 847-458-1500  
Minneapolis Tel: 952-892-9222

**3 - SOUTH REGION**  
Tel: 678-951-8120

**4 - NORTHEAST REGION**  
Tel: 513-398-5500

**ENERGY PROCESS DIVISION**  
Tel: 866-948-1708

**SEMICONDUCTOR DIVISION**  
Tel: 408-754-3370

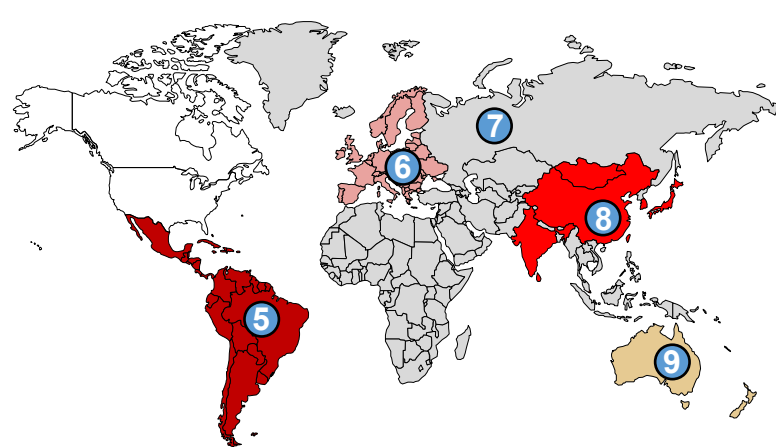

**5 - MEXICO, CENTRAL and SOUTH AMERICA**  
Tel: +52 442-256-2200

**6 - EUROPE**  
**France**  
Tel: +33 (0) 1-41-32-79-70

**Germany**  
Tel: +49 7253-9400-0

**Italy**  
Tel: +39 02-458-8841

**Spain**  
Tel: +34 91-675-1292

**United Kingdom**  
Tel: +44 115-964-0777

**7 - RUSSIA, AFRICA & MIDDLE-EAST**  
Tel: +1 630-879-2696

**8 - ASIA**  
**China**  
Tel: +86 21-3532-8532

**Japan**  
Tel: +81 3-3518-6630

**Korea**  
Tel: +82 2-2169-2600

**Taiwan**  
Tel: +866 7-288-5168

**India**  
Tel: +91 40-666-12700

**9 - AUSTRALIA & NZ**  
Tel: +61 3-9335-6449

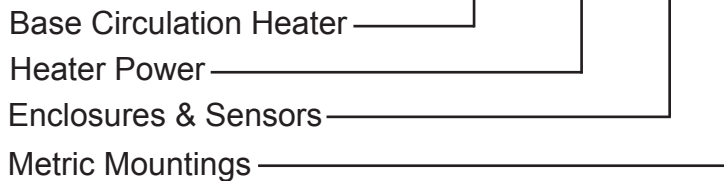

**BX17E6G AAAA-BBB-C****Building a CAST-X 3000 Part Number**

Use the graphs below to build your CAST-X 3000.  
Assigning numbers for sections AAAA and BBB.

If you need metric mountings, assign "M" to section C.  
If metric mounts are not required, leave section C blank.

For assistance, contact CAS directly.

**VOLTAGE, POWER, CIRCUIT TYPE**

*Volts refers to line volts ( $V_L$ ). Amps refers to line current ( $I_L$ ).*

Section "AAAA"	Volts (V)	Watts (kW)	Circuit Type	Amps (A) (per circuit)
300A	480	24.6	TWO THREE-PHASE DELTA CIRCUITS	14.8
300B	480	12.3	ONE THREE-PHASE DELTA CIRCUIT	14.8
300C	480	8.2	ONE THREE-PHASE WYE (PARALLEL) CIRCUIT	9.8
300D	480	6.2	ONE THREE-PHASE DELTA (SERIES)	7.4
300E	480	4.1	ONE SINGLE PHASE CIRCUIT	8.5
300F	480	4.1	ONE THREE-PHASE WYE	4.9
300G	380	15.4	TWO THREE-PHASE DELTA CIRCUITS	11.7
300H	380	7.7	ONE THREE-PHASE DELTA CIRCUIT	11.7
300J	380	5.1	ONE THREE-PHASE WYE (PARALLEL) CIRCUIT	7.8
300K	380	3.9	ONE THREE-PHASE DELTA (SERIES) CIRCUIT	5.9
300L	380	2.6	ONE SINGLE PHASE CIRCUIT	6.7
300M	380	2.6	ONE THREE-PHASE WYE CIRCUIT	3.9
300N	240	27	TWO THREE-PHASE DELTA CIRCUITS	32.5
300P	240	13.5	ONE THREE-PHASE DELTA CIRCUIT	32.5
300Q	240	9.0	ONE THREE-PHASE WYE (PARALLEL) CIRCUIT	21.6
300R	240	6.7	ONE THREE-PHASE DELTA (SERIES) CIRCUIT	16.2
300S	240	4.5	ONE SINGLE PHASE CIRCUIT	18.8
300T	240	4.5	ONE THREE-PHASE WYE CIRCUIT	10.8
300U	208	20.3	TWO THREE-PHASE DELTA CIRCUITS	28
300V	208	10.1	ONE THREE-PHASE DELTA CIRCUIT	28
300W	208	6.8	ONE THREE-PHASE WYE (PARALLEL) CIRCUIT	18.7
300X	208	5.1	ONE THREE-PHASE DELTA (SERIES) CIRCUIT	14.1
300Y	208	3.4	ONE SINGLE PHASE CIRCUIT	16.3
300Z	208	3.4	ONE THREE-PHASE WYE CIRCUIT	9.4

**ENCLOSURES AND SENSORS**

*All thermocouples are ungrounded, for optimal performance*

Section "BBB"	Description	Thermocouple Qty.	Enclosure
W00	NO SENSOR	0	NEMA 4
W0J	J-TYPE THERMOCOUPLE IN THERMOWELL	1	NEMA 4
W0K	K-TYPE THERMOCOUPLE IN THERMOWELL	1	NEMA 4
WJJ	J-TYPE THERMOCOUPLES IN THERMOWELLS	2	NEMA 4
WKK	K-TYPE THERMOCOUPLES IN THERMOWELLS	2	NEMA 4
E00	NO SENSOR	0	NEMA 7 / ATEX
E0J	J-TYPE THERMOCOUPLE IN THERMOWELL	1	NEMA 7 / ATEX
E0K	K-TYPE THERMOCOUPLE IN THERMOWELL	1	NEMA 7 / ATEX
EJJ	J-TYPE THERMOCOUPLES IN THERMOWELLS	2	NEMA 7 / ATEX
EKK	K-TYPE THERMOCOUPLES IN THERMOWELLS	2	NEMA 7 / ATEX

**METRIC MOUNTING HOLES**

*Place an "M" in section C if metric mounting holes are required.*

*If standard Imperial mounting holes are desired, section C can be left blank*

Section "C"	Metric Mounting Holes
M	M10 x 1.5 Metric Tapped Mounting Holes

**CUSTOM DESIGNS & COMPONENTS**

*CAS offers several options for special tubes, sensors, and finishes.*

*For these options, please call a CAS Representative for a quote.*

**Options**

INCONEL, MONEL OR HASTELLOY TUBES	SPECIAL HIGH-LIMIT SWITCHES OR RTDs
ELECTRO-POLISHED OR PASSIVATED TUBES	NPT FITTINGS
SINGLE TUBE DESIGNS	THICK WALL TUBES

## ACCESSORIES

*These PNs are totally separate from the PNs for the heater*

Part Number	Component
274-55-6-7	COMPRESSION FITTINGS (HIGH PRESSURE) / PAIR (SHIPPED LOOSE)
307-0-16-1	INSULATION JACKET, MAXIMUM TEMPERATURE 986°F (530°C)

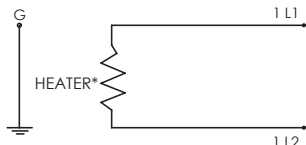

SINGLE PHASE CIRCUIT

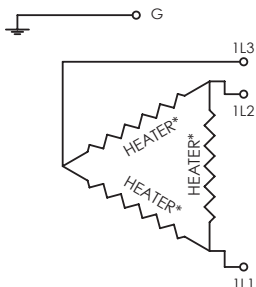

THREE-PHASE DELTA CIRCUIT

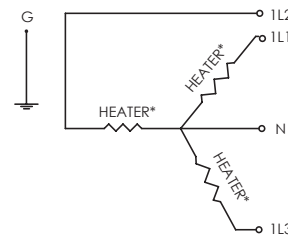

THREE-PHASE WYE CIRCUIT

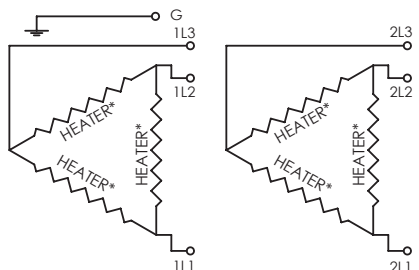

TWO THREE-PHASE DELTA CIRCUITS

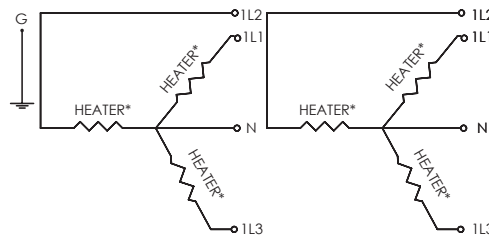

TWO THREE-PHASE WYE CIRCUITS

### CAST-X 3000 Available Circuit Types

The CAST-X 3000 is manufactured with these types of circuit configurations.

\*Wiring schematic only shows heater elements. Refer to I&M Manual for further details on wiring of snap-action switches (if applicable).



NEMA 4 ENCLOSURE



NEMA 7 / ATEX ENCLOSURE

### Need Help with Part Numbers or Engineering Calculations?

The CAS Team is ready and available to help you work through part number configurations, provide engineering advice, and ensure customers purchase the heater most appropriate for their particular application.



**CAST ALUMINUM**  
**Solutions**

Contact CAS Directly:

Main Tel: 630-879-2696

Toll-Free: 888-367-3992

Sales@CastAluminumSolutions.com

www.CastAluminumSolutions.com